

LIDER S.J.

KLUCZE TRZPIENIOWE SZEŚCIOKĄTNE I O PROFILU XZN

OSTROŁĘKA, 11 LISTOPADA 121D

KPL. WKRETAKÓW IMBUSOWYCH

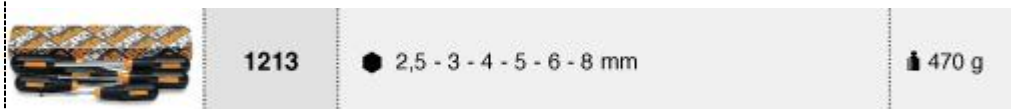

WKRETAK IMBUSOWY



WKRETAK IMBUSOWY 10MM Z KULISTĄ KOŃCÓWKĄ

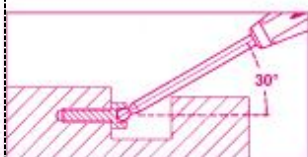

GROT WKRETAKA IMBUSOWY



WKRETAKI Z KOŃC. TRZPIENIOWĄ



KPL. WKRETAKÓW Z KOŃCÓKĄ TRZPIENIOWĄ



WKRETAK Z KOŃCÓWKĄ TRZPIENIOWĄ



WKRETAK KRZYŻOWY IZOLOWANY



KPL. WKRETAKÓW KRZYŻOWYCH IZOLOWANYCH PZ0-4 5SZT



KOŃCÓWKI WKRĘTAKOWE TRZPIEN.



ZESTAW KOŃCÓWEK WKRĘT. + UCHWYT MAG.2-10



KOŃCÓWKA WKRĘTAKOWA TRZPIENIOWA



NASADKA 1/4" Z KOŃCÓWKĄ TRZPIENIOWĄ



NASADKA Z KOŃCÓWKĄ TRZPIENIOWĄ



KPL.NASADEK TRZPIENIOWYCH 3-10MM 7SZT



NASADKA 3/8" Z KOŃCÓWKĄ TRZPIENIOWĄ



NASADKA Z KOŃCÓWKĄ WKRĘTAKOWĄ XZN



KPL.NASADEK TRZPIENIOWYCH 5-17MM 7SZT



KPL.NASADEK TRZPIENIOWYCH 5-17MM 7SZT



KPL.NASADEK TRZPIENIOWYCH 10 SZT



NASADKA 1/2" KOŃCÓWKA TRZPIENIOWA





KPL.NASADEK O PROFILU XZN M6L-12L 4SZT





NASADKA 3/4" Z KOŃCÓWKĄ TRZPIENIOWĄ



KPL.KLUCZY TRZPIENIOWYCH

	951QF	● 2,5 - 3 - 3,5 - 4 - 4,5 - 5 - 6 mm	📦 450 g
	951QF	● 2,5 - 3 - 3,5 - 4 - 4,5 - 5 - 6 - 7 - 8 - 9 10 - 12 - 14 mm	📦 3000 g
	951QF	● 3 - 4 - 5 - 6 - 8 - 10 mm	📦 1035 g

STOJAK DO KLUCZY 951 PUSTY

	951	● 2 - 2,5 - 3 - 3,5 - 4 - 4,5 - 5 - 6 mm	📦 400 g
	951	● 2 - 2,5 - 3 - 3,5 - 4 - 4,5 - 5 - 6 - 7 - 8 - 9 10 - 12 - 14 mm	📦 2850 g
	951	● 3 - 4 - 5 - 6 - 8 - 10 mm	📦 1035 g

KLUCZ TRZPIENIOWY TYPU T

● mm	⌀ H	H mm	L mm	L1 mm	📦 g	● mm	⌀ H	H mm	L mm	L1 mm	📦 g
2,5	1/4	6,0	150	63	22	7	3/8	11	230	109	155
3	1/4	6,5	150	63	22	8	3/8	12	250	122	215
3,5	1/4	7,5	175	76	46	9	3/8	13	265	132	270
4	1/4	8,0	175	76	46	10	1/2	14	280	142	355
4,5	1/4	8,5	195	87	75	12	1/2	15	305	160	600
5	1/4	9,0	195	87	75	14	1/2	17	330	178	850
6	3/8	10,0	215	99	115						

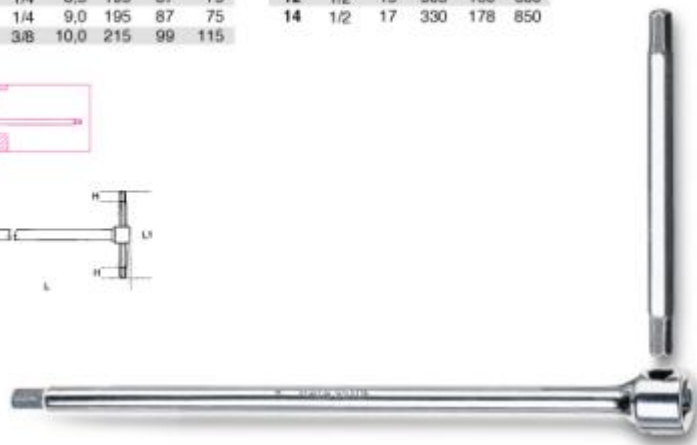

KPL.KLUCZY TRZPIENIOWYCH 3-10MM 9SZT

	953	● 3 - 3,5 - 4 - 4,5 - 5 - 6 - 7 - 8 - 10 mm	📦 2300 g
---	------------	---	----------

KLUCZ TRZPIENIOWY TYPU T PRZEGUB.

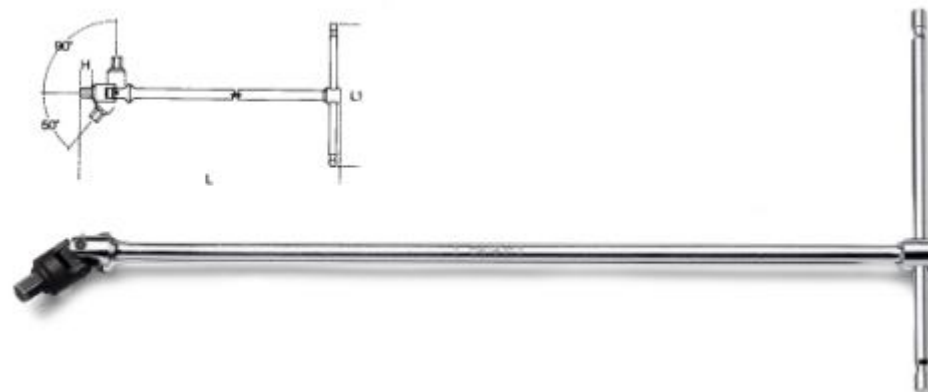
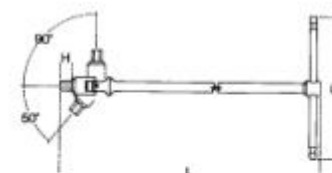

KPL.KLUCZY TRZPIENIOWYCH



96AS

● 3/64 - 1/16 - 5/64 - 3/32 - 1/8 - 5/32 - 3/16
7/32 - 1/4 - 5/16 - 3/8

265 g



96AS

● 3/32 - 1/8 - 5/32 - 3/16 - 1/4 - 5/16 - 3/8

345 g



96AS

● 3/32 - 1/8 - 5/32 - 3/16 - 7/32 - 1/4 - 5/16

170 g



96BPC

● 1,5 - 2 - 2,5 - 3 - 4 - 5 - 6 - 8 - 10 mm

325 g

KLUCZ TRZPIENIOWY KĄTOWY



KLUCZ TRZPIENIOWY KĄTOWY NIEISKRZĄCY



KLUCZ TRZPIE.KĄTOWY Z KULISTĄ KOŃC



KLUCZ TRZPIENIOWY KĄTOWY Z BOLCEM



KLUCZ TRZPIENIOWY KĄTOWY DŁ.CHROM



KLUCZ TRZPIENIOWY Z KULISTĄ KOŃC.

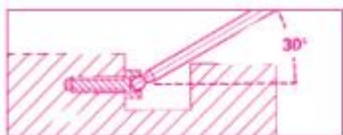

KLUCZ TRZPIENIOWY KĄTOWY



UCHWYT DO KLUCZY 96LM PUSTY

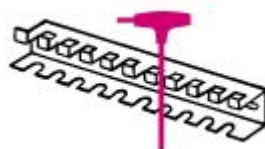

KLUCZ TRZPIENIOWY KĄTOWY DŁUGI



KPL.KLUCZY TRZPIEN.KĄTOWYCH 2,5-10MM 10S



96LM	● 3 - 4 - 5 - 6 - 8 mm	📦 530 g
96LM	● 2,5 - 3 - 3,5 - 4 - 4,5 - 5 - 6 mm	📦 450 g
96LM	● 2,5 - 3 - 3,5 - 4 - 4,5 - 5 - 6 - 7 - 8 - 10 mm	📦 1400 g







KPL.KLUCZY TRZPIEN. KĄTOWYCH



96T	● 3 - 4 - 5 - 6 - 8 mm	📦 530 g
96T	● 2,5 - 3 - 3,5 - 4 - 4,5 - 5 - 6 mm	📦 450 g
96T	● 2 - 2,5 - 3 - 3,5 - 4 - 4,5 - 5 - 6 - 7 - 8 - 10 mm	📦 1400 g



POKROWIEC

	96	● 2,5 - 3 - 4 - 5 - 6 - 8 mm	📦 140 g
	96	● 2 - 2,5 - 3 - 4 - 5 - 6 - 8 - 10 mm	📦 240 g
	96	● 1,5 - 2 - 2,5 - 3 - 4 - 5 - 6 - 8 - 10 - 12 mm	📦 405 g
	96	● 1,5 - 2 - 2,5 - 3 - 4 - 5 - 6 - 8 - 10 mm	📦 240 g
	96	● 2 - 2,5 - 3 - 3,5 - 4 - 4,5 - 5 - 6 - 7 - 8 9 - 10 mm	📦 475 g

WIESZAK DO KLUCZY



KLUCZ TRZPIENIOWY KĄTOWY PROFIL XZN



KPL.7 KLUCZY TRZPIEN.Z KOŃC.SZEŚCI.ACT.

