

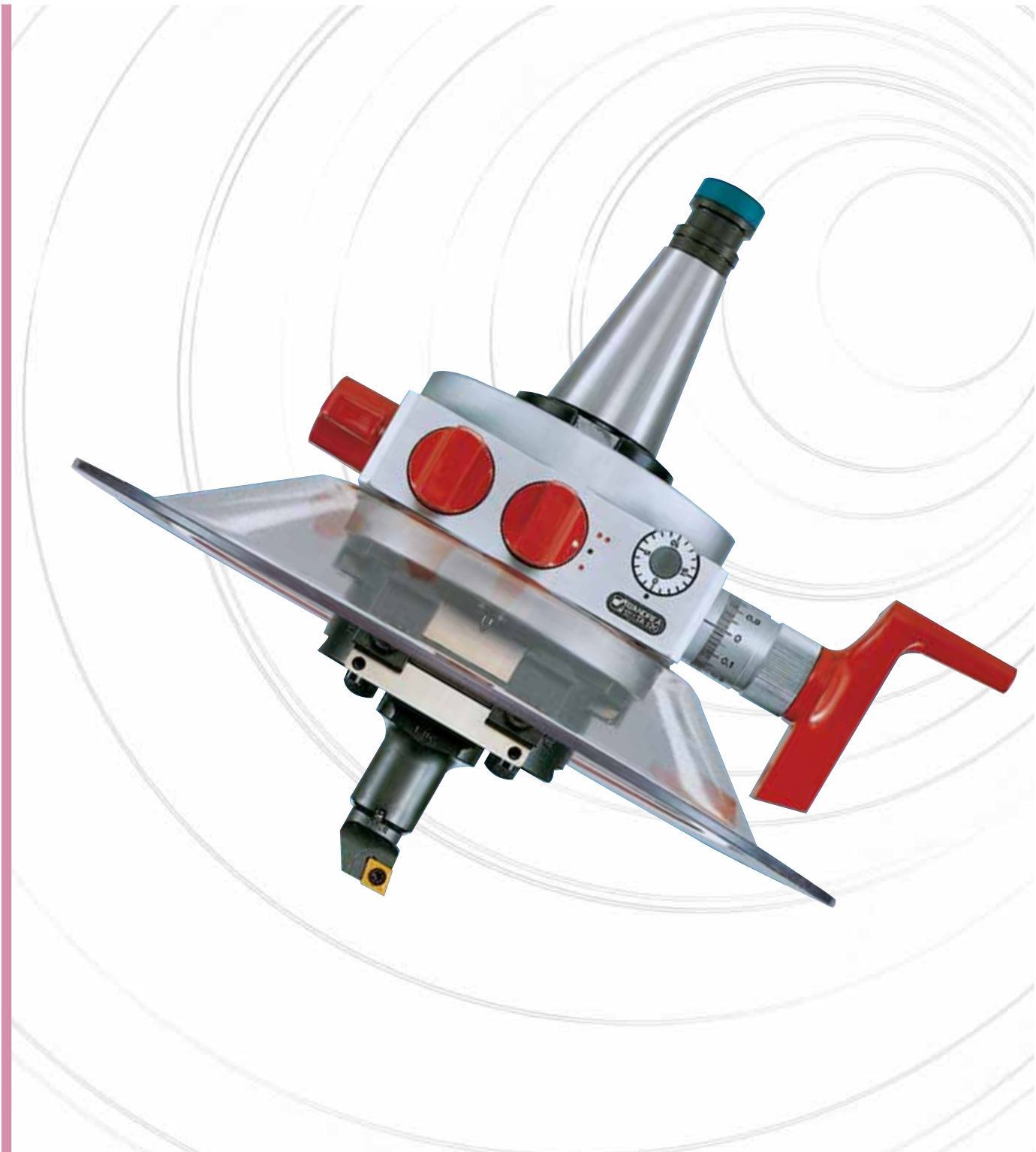

## **SENSITIV T-TA**

**Boring and facing heads with manual and automatic feed**



# SENSITIV T-TA

## General features

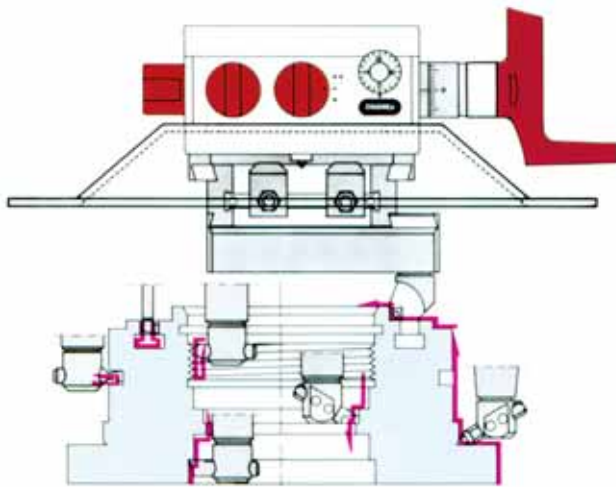

The line of T-TA boring and facing heads is provided with radial feed movement of the radial slide while the head rotates. The radial feed can be either manually operated by a crank or automatic. Via an interchangeable taper, these heads can be utilized on milling machines, boring machines, jig boring machine, radial drills and will allow to perform a wide range of machining

operations such as facing, back-facing, boring, taper boring, grooving both on ID or OD.

The T-TA line of heads includes 4 models: T 100 provided with manual radial feed only; TA 120, TA 170 and TA 220 provided with manual and automatic radial feed. A wide range of toolholders is available for these heads to allow the widest range of machining operations.



10

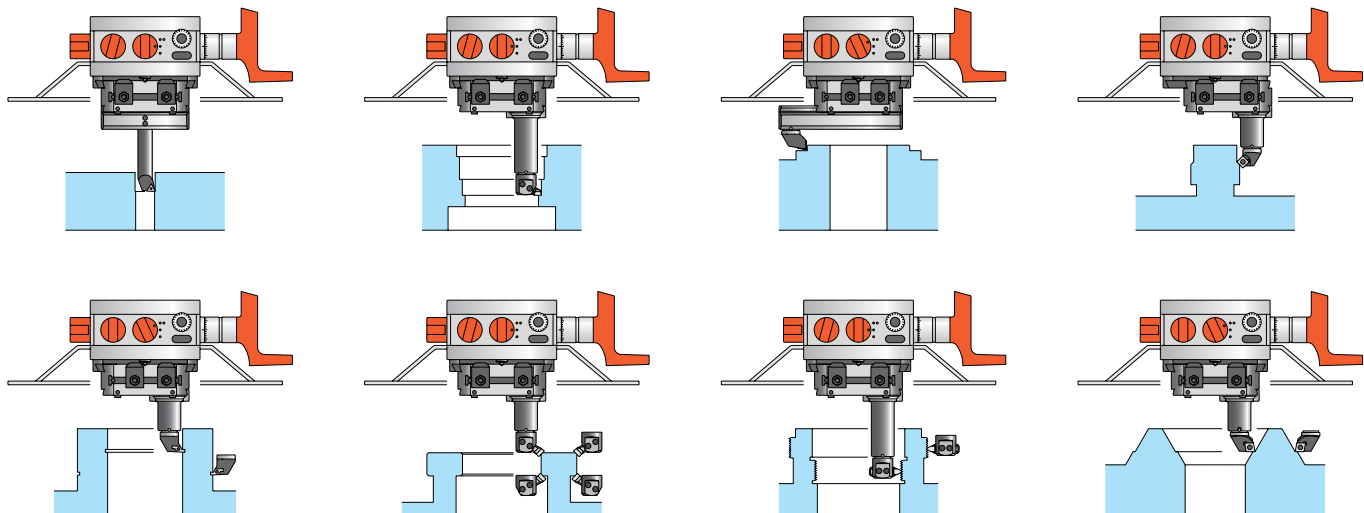

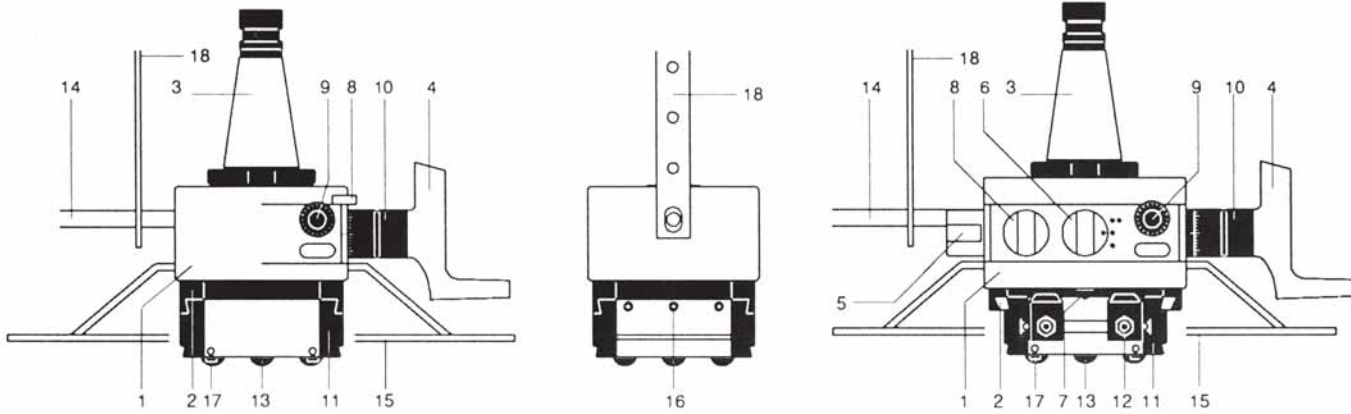

**COMPONENTS**

- 1. Stationary body
- 2. Rotating body
- 3. Interchangeable body
- 4. Feed crank

- 5. Quick return crank
- 6. Automatic feed crank
- 7. Automatic feed disengage button

- 8. Crank lock
- 9. Micrometric vernier scale
- 10. Centesimal vernier scale
- 11. Tool slide

- 12. Position stop
- 13. Toolholder clamp screw
- 14. Check rod
- 15. Transparent guard

- 16. Slide clamp screw
- 17. Toolholder check pins
- 18. Fork

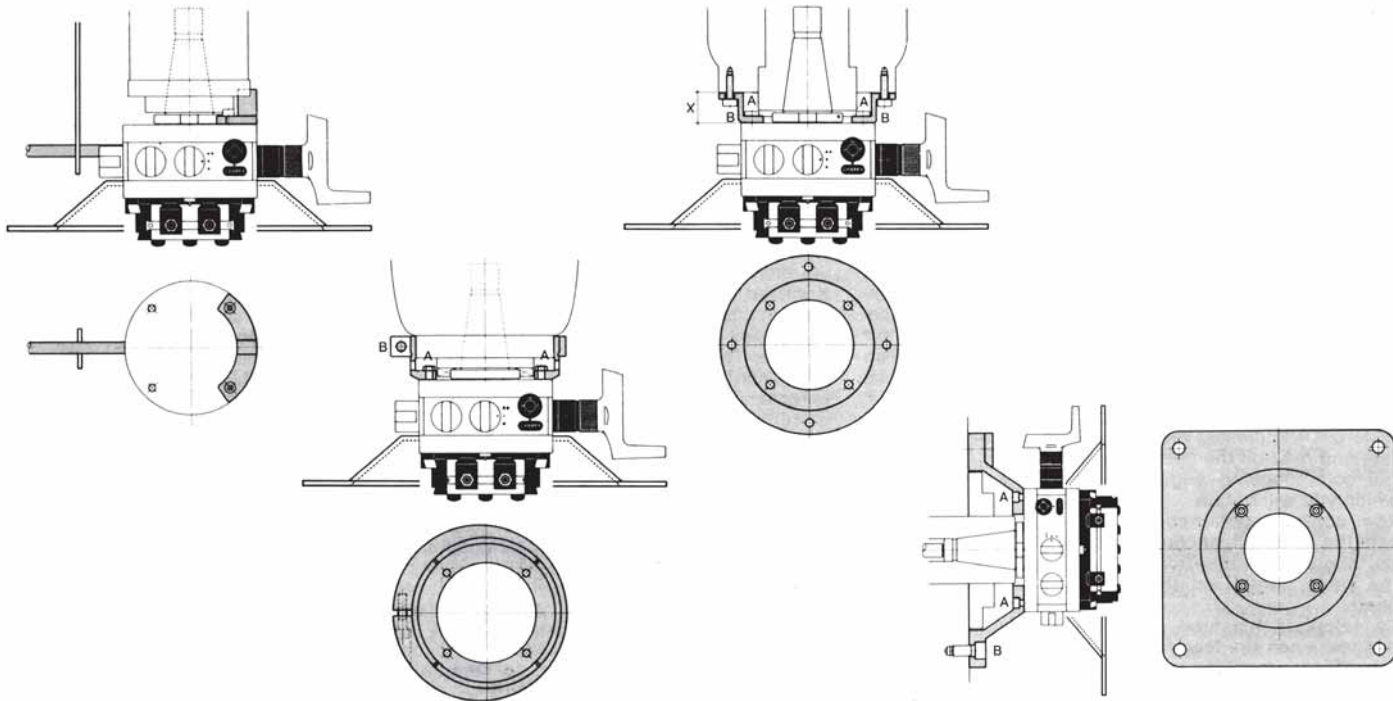

**ASSEMBLY**

The SENSITIV are mounted on the machine via the taper. The check rod 14, inserted in fork 18 and locked onto the machine

head, prevents the fixed body from rotating. For severe, heavy tooling, it is advisable to apply a flange to block the

SENSITIV onto the sleeve or the head of the machine tool. The type of flange to be used depends on the machine model and on

whether or not there are threaded holes in the front of the spindle or machine head. The flange may be easily built by the

customer or supplied by D'Andrea.

# SENSITIV T-TA

Supply

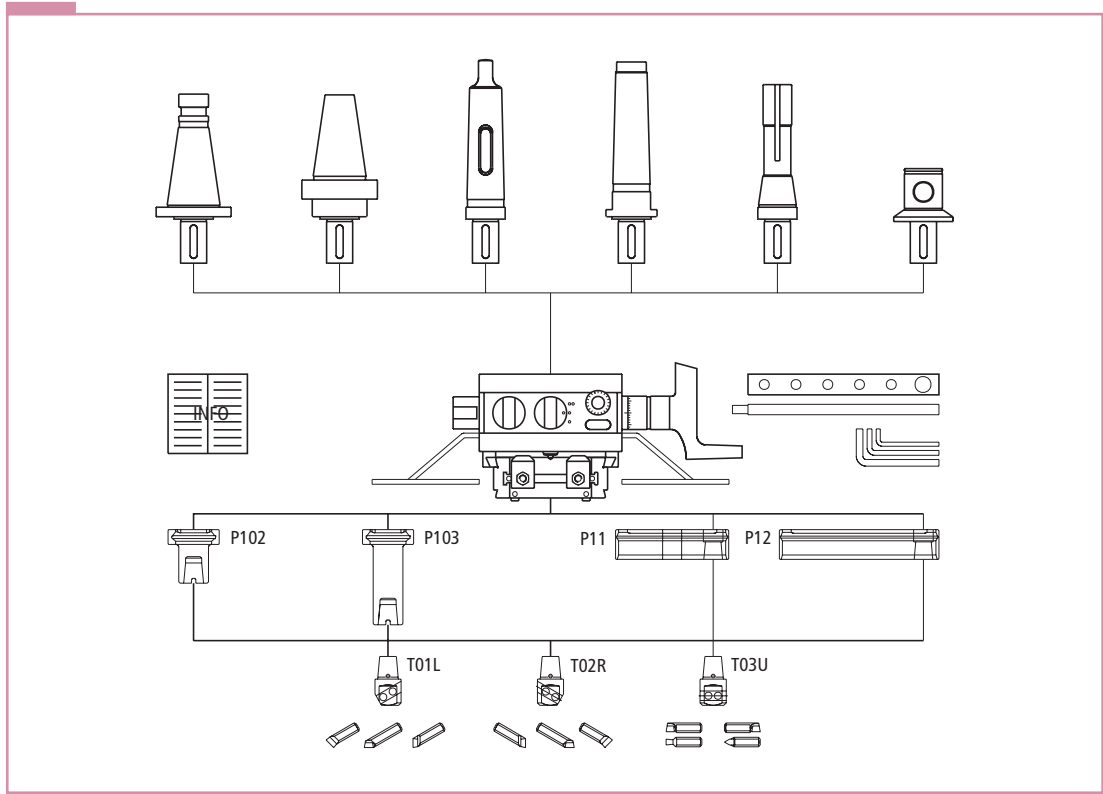

The standard K01 Kit includes the following in a case: 1 T or TA head; 1 transparent guard; 2 boring toolholders (P102, P103), 2 facing toolholders (P11, P12), 3 heads (T01, T02, T03), 10 carbide tools; 1 check rod; 1 set of wrenches; 1 instruction booklet; 1 warranty card. Other accessories are also available upon request. Fitting tapers are optional.

**SAFETY**  
The T-TA are equipped with a transparent guard that ensures safe use. In addition, the toolholder slide is fitted with a safety device that prevents the toolholder from being released.

## KIT K01

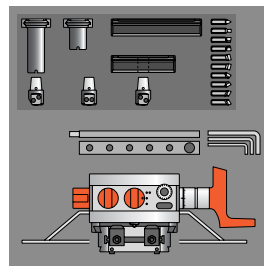

consisting of:

- 1 T./TA..                      1 T 01L
- 1 P 102                        1 T 02R
- 1 P 103                        1 T 03U
- 1 P 11                            10 Tools M20
- 1 P 12

REF.	T100 CODE	TA 120 CODE	TA 170 CODE	TA 220 CODE
K01	50 01 100 21 001	50 02 120 21 001	50 02 170 21 001	50 02 220 21 001

## KIT K03

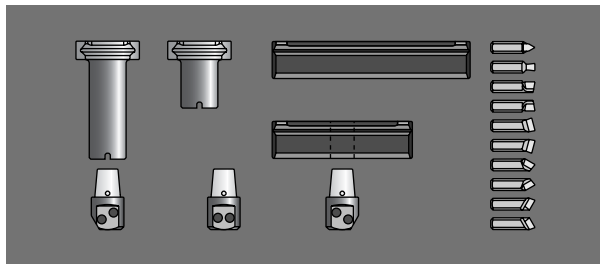

consisting of:

- 1 P 102                        1 T 01L
- 1 P 103                        1 T 02R
- 1 P 11                            1 T 03U
- 1 P 12                            10 Tools M20

REF.	T 100 - TA 120 CODE	TA 170 CODE	TA 220 CODE
K03	50 02 120 23 000	50 02 170 23 000	50 02 220 23 000

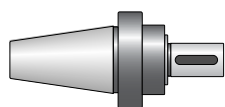

REF.		T 100 - TA 120 CODE	TA 170 CODE	TA 220 CODE
DIN 69871/CAT ISO 7388	ISO 40	41 1 22 01 040 35	41 1 32 01 040 35	-
	ISO 50	41 1 22 01 050 35	41 1 32 01 050 35	41 1 50 01 050 35
MAS-BT	ISO 40	41 1 22 01 040 36	41 1 32 01 040 36	-
	ISO 50	41 1 22 01 050 35	41 1 32 01 050 35	41 1 50 01 050 35

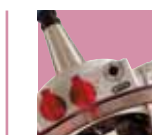
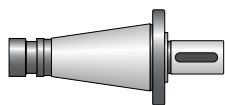

13

REF.		T 100 - TA 120 CODE	TA 170 CODE	TA 220 CODE
DIN 2080 "OTT"	ISO 40	41 1 22 01 040 00	41 1 32 01 040 00	-
	ISO 40 inch	41 1 22 01 040 04	41 1 32 01 040 04	-
	ISO 50	41 1 22 01 050 00	41 1 32 01 050 00	41 1 50 01 050 00
	ISO 50 inch	41 1 22 01 050 04	41 1 32 01 050 04	41 1 50 01 050 04

### CHUCKING TOOL FOR MHD' ARBORS

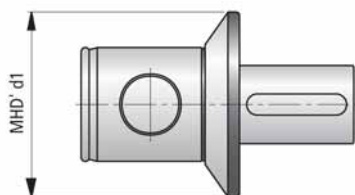

REF.	T100 - TA 120 CODE	MHD' d1
MHD' 50 T100 / TA120	41 1 22 00 050 00	50
REF.	TA 170 CODE	MHD' d1
MHD' 63 TA 170	41 1 32 00 063 00	63
REF.	TA 220 CODE	MHD' d1
MHD' 80 TA 220	41 1 50 00 080 00	80

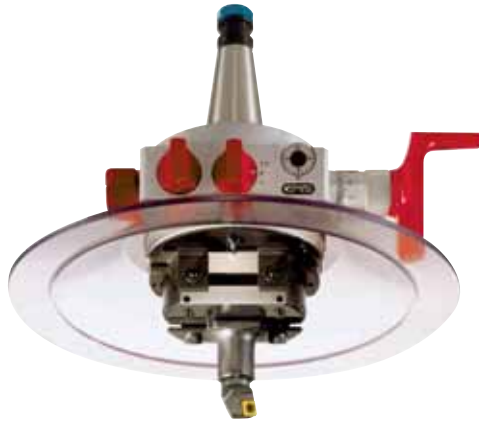

T and TA heads are designed for applying modular toolholders and interchangeable fitting tapers. All heads are made with dovetail guides on the slide for mounting the tool holders. This allows optimum positioning of the toolholders and ensures

that they are very securely fastened in place. The toolholders have a tapered fitting for inserting the interchangeable heads available in right and left versions, screw-locking positive inserts and for round tools specifically made of carbide (M20).

### BORING TOOLHOLDERS

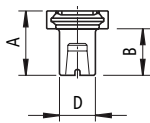

P102

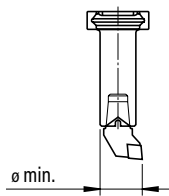

P103

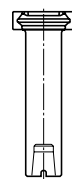

P104

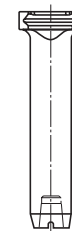

P105

	REF.	CODE	A	B	D	Ø min.
T 100 - TA 120	P102	43 10 30 25 055 1	45	32,5	25	31
	P103	43 10 30 25 090 1	80	67,5		
	P104	43 10 30 25 125 1	115	102,5	28	33
	P105	43 10 30 28 160 1	150	137,5		
TA 170	P102	43 10 40 32 080 1	67	51	32	40
	P103	43 10 40 32 125 1	112	96		
	P104	43 10 40 32 160 1	147	131		
	P105	43 10 40 32 200 1	187	171		
TA 220	P102	43 10 50 40 100 1	83.5	63,5	40	50
	P103	43 10 50 40 160 1	143.5	123.5		
	P104	43 10 50 40 200 1	183.5	163.5		
	P105	43 10 50 40 250 1	233.5	213.5		

### FACING TOOLHOLDERS

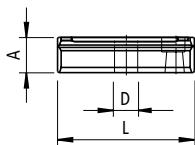

P11



P12

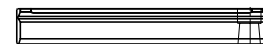

P13

	REF.	CODE	L	A	Ø
T 100 - TA 120	P11	43 30 30 30 096 0	95	25	16
	P12	43 30 30 30 135 0	135		
	P13	43 30 30 30 175 0	175		
TA 170	P11	43 30 40 40 140 0	140	40	20
	P12	43 30 40 40 200 0	200		
	P13	43 30 40 40 260 0	260		
TA 220	P11	43 30 50 50 190 0	190	50	25
	P12	43 30 50 50 290 0	290		
	P13	43 30 50 50 390 0	390		

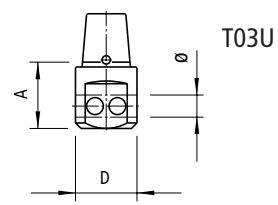
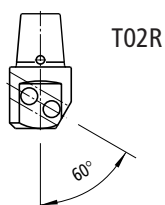
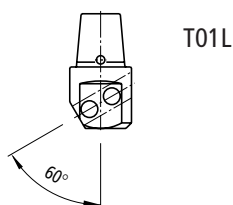

	REF.	CODE	D	A	Ø
T 100 - TA 120	T01 L	46 01 020 08 4 10	22	23.5	8
	T02 R	46 01 020 08 4 20			
	T03 U	46 01 020 08 7 30			
TA 170	T01 L	46 01 025 10 4 10	27	29.5	10
	T02 R	46 01 025 10 4 20			
	T03 U	46 01 025 10 7 30			
TA 220	T01 L	46 01 032 12 4 10	34	37	12
	T02 R	46 01 032 12 4 20			
	T03 U	46 01 032 12 7 30			



15

### M20

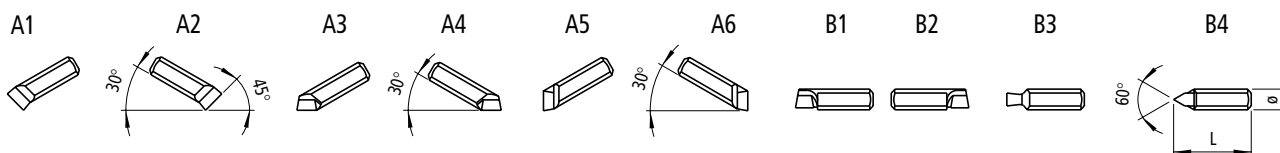

T 100 TA 120				TA 170				TA 220			
REF.	CODE	Ø	L	REF.	CODE	Ø	L	REF.	CODE	Ø	L
A1 08 M20	47 201 02 08 001	8	30	A1 10 M20	47 201 02 10 001	10	45	A1 12 M20	47 201 02 12 001	12	56
A2 08 M20	47 201 02 08 002			A2 10 M20	47 201 02 10 002			A2 12 M20	47 201 02 12 002		
A3 08 M20	47 201 02 08 003			A3 10 M20	47 201 02 10 003			A3 12 M20	47 201 02 12 003		
A4 08 M20	47 201 02 08 004			A4 10 M20	47 201 02 10 004			A4 12 M20	47 201 02 12 004		
A5 08 M20	47 201 02 08 005			A5 10 M20	47 201 02 10 005			A5 12 M20	47 201 02 12 005		
A6 08 M20	47 201 02 08 006			A6 10 M20	47 201 02 10 006			A6 12 M20	47 201 02 12 006		
B1 08 M20	47 201 02 08 101			B1 10 M20	47 201 02 10 101			B1 12 M20	47 201 02 12 101		
B2 08 M20	47 201 02 08 102			B2 10 M20	47 201 02 10 102			B2 12 M20	47 201 02 12 102		
B3 08 M20	47 201 02 08 103			B3 10 M20	47 201 02 10 103			B3 12 M20	47 201 02 12 103		
B4 08 M20	47 201 02 08 104			B4 10 M20	47 201 02 10 104			B4 12 M20	47 201 02 12 104		

# SENSITIV T-TA

## Accessories

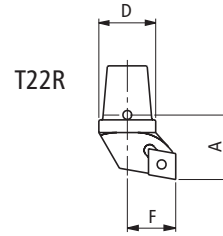
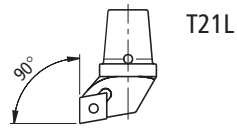

	REF.	CODE	D	A	F			
T 100 - TA 120	T21 L	46 01 020 11 0 10	20	22.5	17			
	T22 R	46 01 020 11 0 20						
TA 170	T21 L	46 01 025 16 0 10	25	29	22			
	T22 R	46 01 025 16 0 20						
TA 220	T21 L	46 01 032 16 0 10	32	36.5	27			
	T22 R	46 01 032 16 0 20						



16

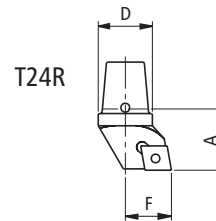
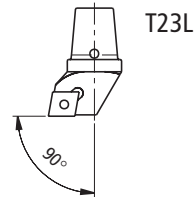



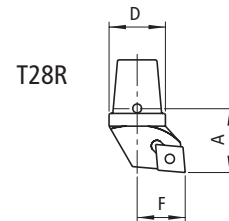
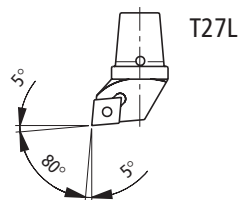

	REF.	CODE	D	A	F			
T 100 - TA 120	T23 L	46 01 020 11 7 10	20	22.5	17			
	T24 R	46 01 020 11 7 20						
TA 170	T23 L	46 01 025 16 7 10	25	29	22			
	T24 R	46 01 025 16 7 20						
TA 220	T23 L	46 01 032 16 7 10	32	36.5	27			
	T24 R	46 01 032 16 7 20						



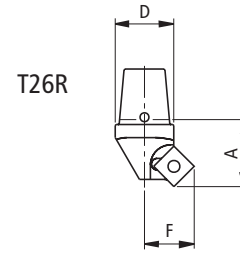
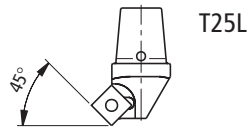



	REF.	CODE	D	A	F			
T 100 - TA 120	T27 L	46 01 020 09 9 10	20	22.5	17			
	T28 R	46 01 020 09 9 20						
TA 170	T27 L	46 01 025 09 9 10	25	29	22			
	T28 R	46 01 025 09 9 20						
TA 220	T27 L	46 01 032 12 9 10	32	36.5	27			
	T28 R	46 01 032 12 9 20						



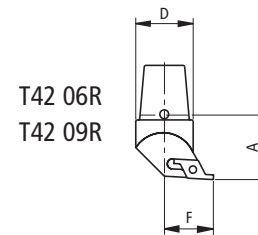
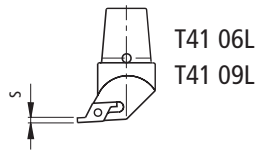

	REF.	CODE	D	A	F			
T 100 - TA 120	T25 L	46 01 020 09 3 10	20	22.5	17	SCMT 09T3..	49 40 1 0004008	10 150 09 0150 0
	T26 R	46 01 020 09 3 20						
TA 170	T25 L	46 01 025 09 3 10	25	29	20	SCMT 09T3..	49 40 1 0004008	10 150 09 0150 0
	T26 R	46 01 025 09 3 20						
TA 220	T25 L	46 01 032 12 3 10	32	36.5	25	SCMT 1204..	49 40 1 0005009	10 150 09 0250 0
	T26 R	46 01 032 12 3 20						



	REF.	CODE	D	A	F			
T 100 - TA 120	T41.06 L	46 01 020 06 8 10	20	22.5	17	X61 0602-..	49 20 1 0025050	10 150 09 0070 0
	T42.06 R	46 01 020 06 8 20						
TA 170	T41.06 L	46 01 025 06 8 10	25	29	22	X61 0602-..	49 20 1 0025050	10 150 09 0070 0
	T42.06 R	46 01 025 06 8 20						
	T41.09 L	46 01 025 09 8 10				X61 09T3-..	49 20 1 0030080	10 150 09 0090 0
	T42.09 R	46 01 025 09 8 20						
TA 220	T41.06 L	46 01 032 06 8 10	32	36.5	27	X61 0602-..	49 20 1 0025050	10 150 09 0070 0
	T42.06 R	46 01 032 06 8 20						
	T41.09 L	46 01 032 09 8 10				X61 09T3-..	49 20 1 0030080	10 150 09 0090 0
	T42.09 R	46 01 032 09 8 20						

On right heads (R) left inserts (L) are used and vice versa



# SENSITIV T-TA

## Technical data

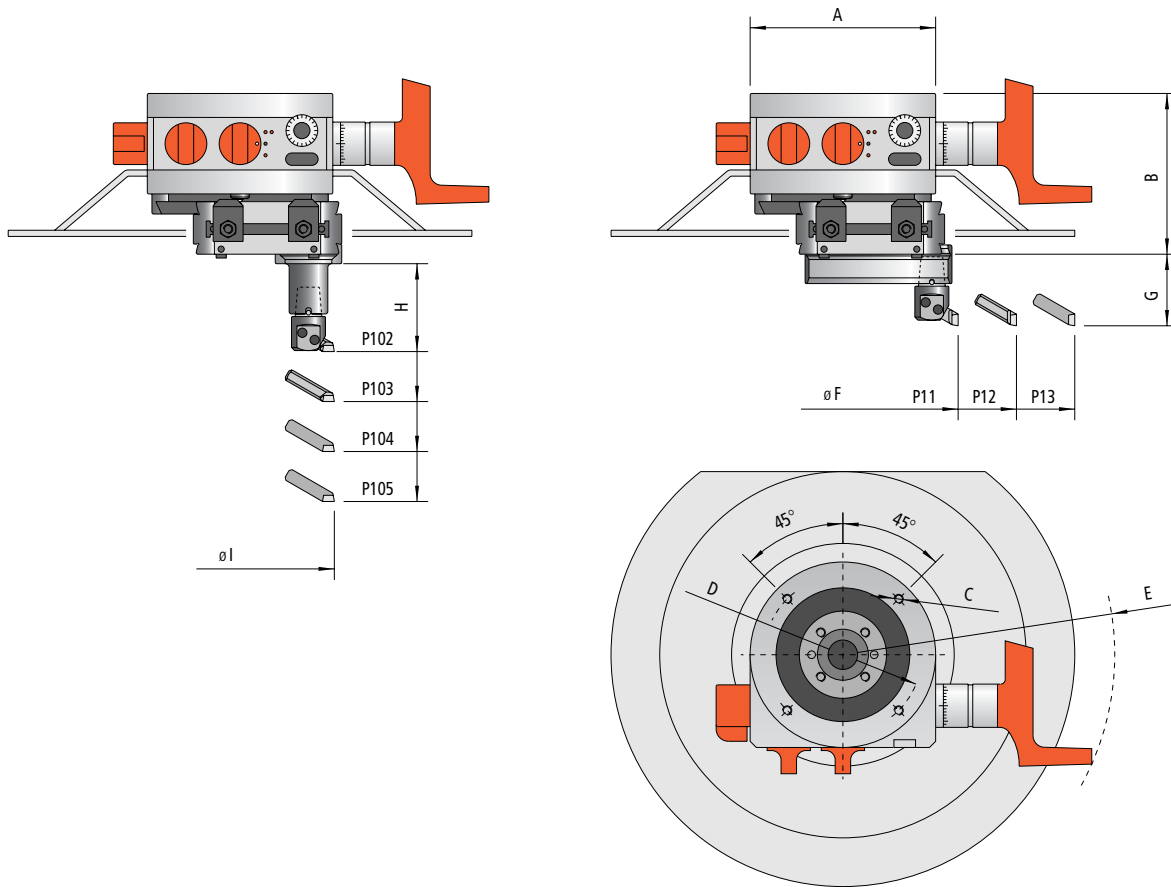

18

TECHNICAL DATA			T 100		TA 120		TA 170		TA 220	
A	mm	inch	102	4.01"	120	4.72"	170	6.69"	220	8.66"
B	mm	inch	100	3.93"	103	4.05"	128	5.03"	168	6.61"
C	mm	inch	M6		M6		M8		M12	
D	mm	inch	88	3.46"	102	4.01"	144	5.66"	190	7.48"
E	mm	inch	160	6.29"	178	7.00"	248	9.76"	283	11.14"
F max P 11 standard	mm	inch	140	5.51"	150	5.90"	220	8.66"	320	12.6"
P 12 standard	mm	inch	200	7.87"	210	8.26"	300	11.81"	420	16.53"
P 13	mm	inch	250	9.84"	300	11.81"	400	15.74"	500	19.68"
G	mm	inch	47	1.85"	47	1.85"	61	2.40"	77	3.03"
H P102 standard	mm	inch	55	2.16"	55	2.16"	80	3.14"	100	3.93"
P103 standard	mm	inch	90	3.54"	90	3.54"	125	4.92"	160	6.29"
P104	mm	inch	125	4.92"	125	4.92"	160	6.29"	200	7.87"
P105	mm	inch	160	6.29"	160	6.29"	200	7.87"	250	9.84"
I max.	mm	inch	115	4.52"	125	4.92"	190	7.48"	280	11.02"
Radial trasverse	mm	inch	30	1.18"	40	1.57"	60	2.36"	100	3.93"
• Feed	mm/°	inch/°	-	-	0.05	.002"	0.05	.002"	0.062	.0025"
• • Feed	mm/°	inch/°	-	-	0.15	.006"	0.15	.006"	0.186	.0073"
Rapid return	mm/°	inch/°	-	-	0.4	.015"	1	.039"	1.24	.048"
Max. speed	RPM	RPM	1000	1000	800	800	630	630	500	500
Net weight	kg	pound	4.6	10.12	6.5	14.3	19	41.8	36	79.2
Torque	Nm	lb ft.	400	296	400	296	800	592	1500	1110
Motor power	Kw	hp	2 ÷ 6	2.68 ÷ 8.04	2 ÷ 6	2.68 ÷ 8.04	3.5 ÷ 11	4.69 ÷ 14.74	7.5 ÷ 22	10.05 ÷ 29.48

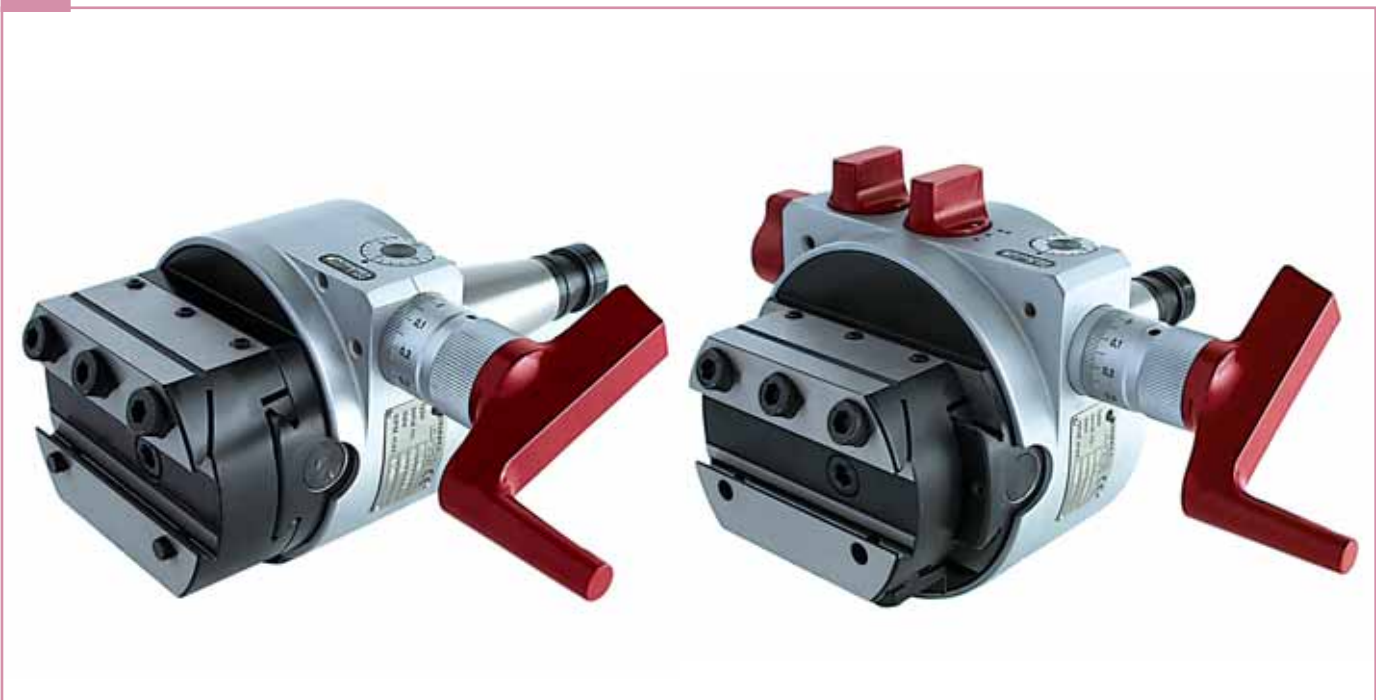

19

